

## Description

The JS24U1GD60-2 is a uni-directional TVS diode, utilizing leading monolithic silicon technology to provide fast response time and low ESD clamping voltage, making this device an ideal solution for protecting voltage sensitive data and power line. The JS24U1GD60-2 complies with the IEC 61000-4-2 (ESD) standard with  $\pm 30\text{kV}$  air and  $\pm 30\text{kV}$  contact discharge. It is assembled into an ultra-small 1.6x1.0x0.5mm lead-free DFN package. The small size and high ESD surge protection make JS24U1GD60-2 an ideal choice to protect cell phone, digital cameras, audio players and many other portable applications.

## Circuit Diagram

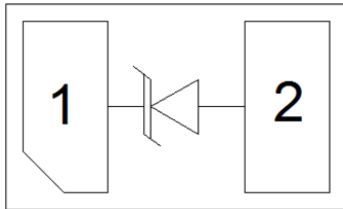

Circuit Diagram

## Marking Diagram

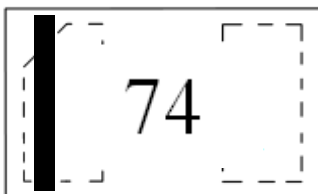

### Transparent top view

74: Device Marking Code  
Bar denotes cathode

## Features

- \* Protects one data or power line
- \* Low leakage: nA level
- \* Operating voltage: 24V
- \* Low clamping voltage
- \* 2-pin leadless package
- \* Complies with following standards:
  - IEC 61000-4-2 (ESD) immunity test
    - Air discharge:  $\pm 30\text{kV}$
    - Contact discharge:  $\pm 30\text{kV}$
  - IEC61000-4-5 (Lightning) 31A (8/20 $\mu\text{s}$ )
- \* RoHS Compliant
- \* Package: DFN1610-2

## Applications

- \* Mobile Phones
- \* Battery Protection
- \* Power Line Protection
- \* Vbat pin for Mobile Devices
- \* Hand Held Portable Applications

## Ordering Information

Part Number	Packaging	Reel Size
JS24U1GD60-2	3000/Tape & Reel	7 inch

**Absolute Maximum Ratings ( $T_A=25^{\circ}\text{C}$  unless otherwise specified)**

Parameter	Symbol	Value	Unit
Peak Pulse Power (8/20 $\mu\text{s}$ )	Ppk	1400	W
Peak Pulse Current (8/20 $\mu\text{s}$ )	IPP	31	A
ESD per IEC 61000-4-2 (Air)	VESD	$\pm 30$	kV
ESD per IEC 61000-4-2 (Contact)		$\pm 30$	
Operating Temperature Range	TJ	-55 to +125	$^{\circ}\text{C}$
Storage Temperature Range	Tstg	-55 to +150	$^{\circ}\text{C}$

**Electrical Characteristics ( $T_A=25^{\circ}\text{C}$  unless otherwise specified)**

Parameter	Symbol	Test Condition	Min	Typ	Max	Unit
Reverse Working Voltage	$V_{RWM}$				24	V
Breakdown Voltage	$V_{BR}$	$I_T = 1\text{mA}$	26	28	30	V
Reverse Leakage Current	$I_R$	$V_{RWM} = 24\text{V}$			0.5	$\mu\text{A}$
Clamping Voltage	$V_C$	$I_{PP} = 1\text{A}$ (8 x 20 $\mu\text{s}$ pulse)			32	V
Clamping Voltage	$V_C$	$I_{PP} = 31\text{A}$ (8 x 20 $\mu\text{s}$ pulse)			46	V
Junction Capacitance	$C_J$	$V_R = 0\text{V}$ , $f = 1\text{MHz}$		170	200	pF

**Portion Electronics Parameter**

Symbol	Parameter
$I_T$	Test Current
$I_{PP}$	Maximum Reverse Peak Pulse Current
$V_C$	Clamping Voltage @ $I_C$

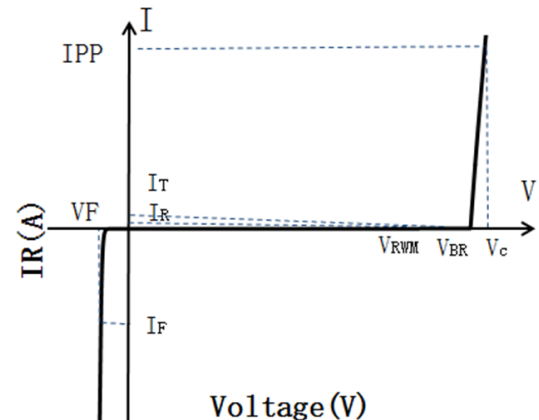

Typical Performance Characteristics ( $T_A=25^\circ\text{C}$  unless otherwise Specified)

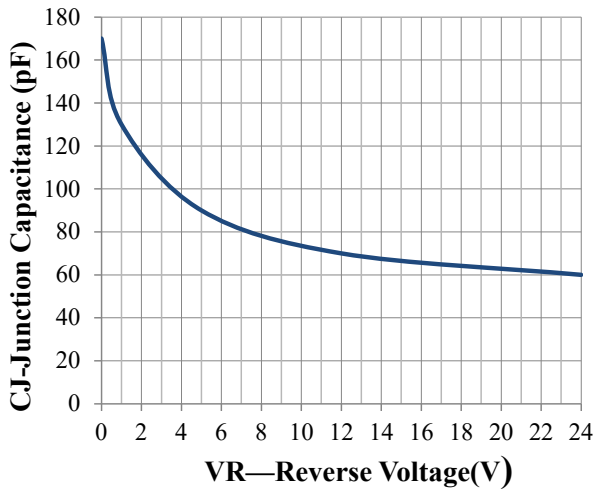

Junction Capacitance vs. Reverse Voltage

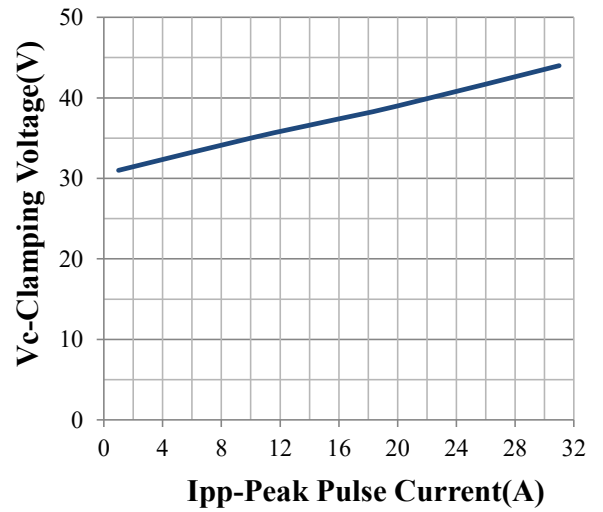

Clamping Voltage vs. Peak Pulse Current

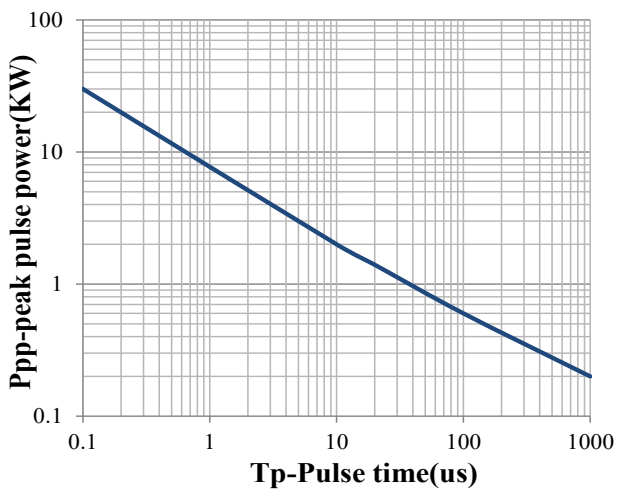

Peak Pulse Power vs. Pulse Time

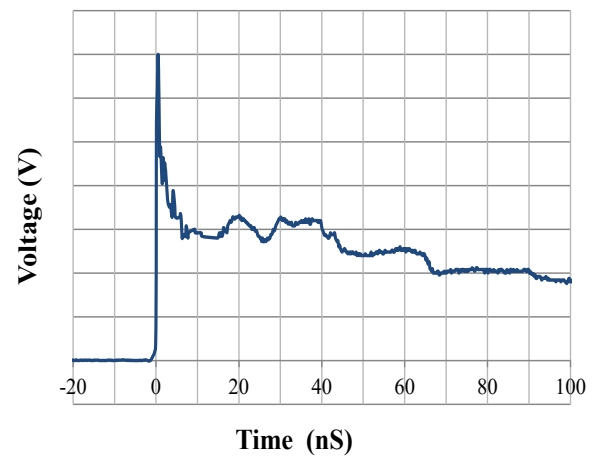

IEC61000-4-2 Pulse Waveform

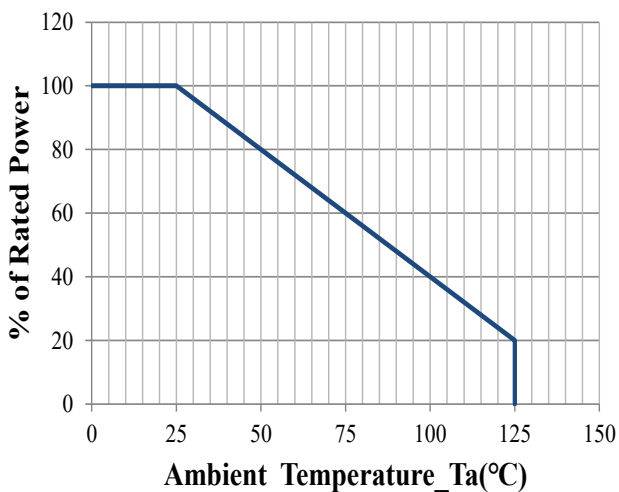

Power Derating Curve

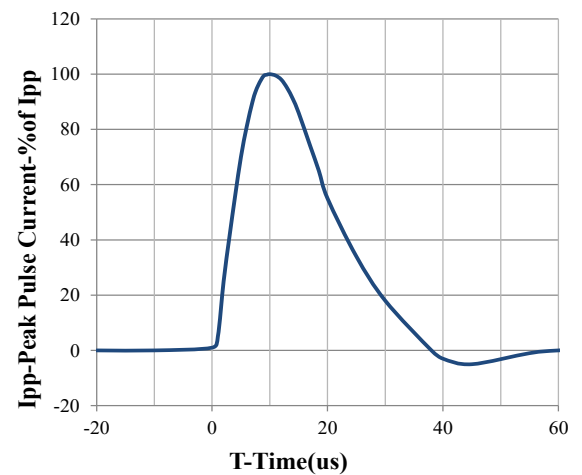

8 X 20us Pulse Waveform

## DFN1610-2 Package Outline Drawing

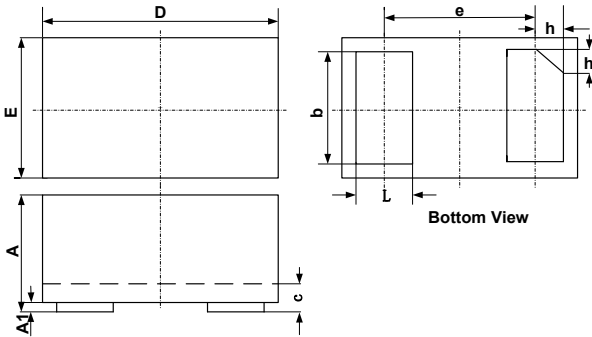

SYM	DIMENSIONS					
	MILLIMETERS			INCHES		
	MIN	NOM	MAX	MIN	NOM	MAX
A	0.45	0.50	0.55	0.018	0.020	0.022
A1	0.00	0.02	0.05	0.000	0.001	0.002
b	0.75	0.80	0.85	0.030	0.032	0.034
c	0.10	0.15	0.20	0.004	0.006	0.008
D	1.55	1.60	1.65	0.062	0.064	0.066
e	1.10 BSC			0.044 BSC		
E	0.95	1.00	1.05	0.038	0.040	0.042
L	0.35	0.40	0.45	0.014	0.016	0.018
h	0.15	0.20	0.25	0.006	0.008	0.010

## Suggested Land Pattern

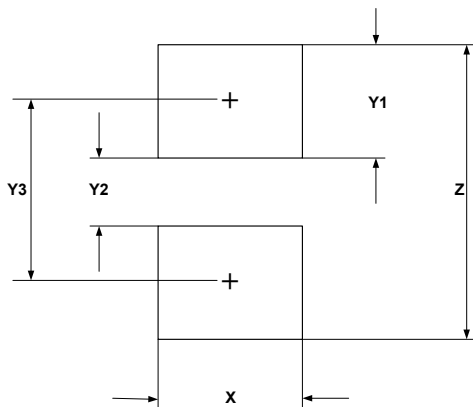

SYM	DIMENSIONS	
	MILLIMETERS	INCHES
X	1.00	0.040
Y1	0.62	0.025
Y2	0.60	0.024
Y3	1.22	0.049
Z	1.85	0.074

## NOTICE

Jelan-Link reserves the right to make changes without further notice to any products here in.

Only obligations are those in the Jelan-Link Standard Terms and Conditions of Sale and in no case will Jelan-Link be liable for any incidental, indirect, or consequential damages arising from the sale, resale, use, or misuse of its products.