

# JE05U4RD40-10

## 4-Line Uni-directional TVS Diode



### Description

The JE05U4RD40-10 is an ultra low capacitance TVS array, utilizing leading monolithic silicon technology to provide fast response time and low ESD clamping voltage, making this device an ideal solution for protecting voltage sensitive high-speed data lines. The JE05U4RD40-10 has an ultra-low capacitance with a typical value at 0.4pF, and complies with the IEC 61000-4-2 (ESD) standard with  $\pm 25\text{kV}$  air and  $\pm 20\text{kV}$  contact discharge. It is assembled into a 10-pin 2.5x1.0x0.5mm lead-free DFN package. The flow through style package allows for easy PCB layout and matched trace lengths necessary to maintain consistent impedance between high speed differential lines such as USB 3.0 and HDMI. The small size, ultra-low capacitance and high ESD surge protection make JE05U4RD40-10 an ideal choice to protect HDMI, MDDI, USB 3.0 and other high speed ports.

### Features

- \* Ultra low capacitance: 0.4pF typical
- \* Operating voltage: 5V
- \* Low clamping voltage
- \* Up to 4 lines protects
- \* Leadless flow-through package
- \* Complies with following standards:
  - IEC 61000-4-2 (ESD) immunity test
  - Air discharge:  $\pm 25\text{kV}$
  - Contact discharge:  $\pm 20\text{kV}$
  - IEC61000-4-5 (Lightning) 4A (8/20 $\mu\text{s}$ )
- \* RoHS Compliant
- \* Package: DFN2510-10

### Circuit Diagram

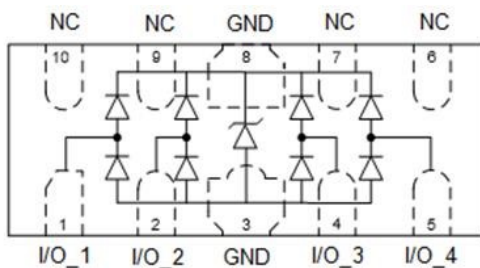

### Applications

- \* HDMI 1.4& 2.0, USB 2.0 & 3.0 and MDDI ports
- \* Monitors and flat panel displays
- \* Set-top box and Digital TV
- \* Video graphics cards
- \* Digital Video Interface (DVI)
- \* Notebook Computers
- \* PCI Express and Serial SATA Ports

### Ordering Information

Part Number	Packaging	Reel Size
JE05U4RD40-10	3000/Tape & Reel	7 inch

**Absolute Maximum Ratings ( $T_A=25^{\circ}\text{C}$  unless otherwise specified)**

Parameter	Symbol	Value	Unit
Peak Pulse Power (8/20 $\mu\text{s}$ )	Ppk	60	W
Peak Pulse Current (8/20 $\mu\text{s}$ )	IPP	4	A
ESD per IEC 61000-4-2 (Air)	VESD	$\pm 25$	kV
ESD per IEC 61000-4-2 (Contact)		$\pm 20$	
Operating Temperature Range	TJ	-55 to +125	$^{\circ}\text{C}$
Storage Temperature Range	Tstg	-55 to +150	$^{\circ}\text{C}$

**Electrical Characteristics ( $T_A=25^{\circ}\text{C}$  unless otherwise specified)**

Parameter	Symbol	Test Condition	Min	Typ	Max	Unit
Reverse Working Voltage	$V_{RWM}$				5.0	V
Breakdown Voltage	$V_{BR}$	$I_T = 1\text{mA}$	6.0	7.5	8.5	V
Reverse Leakage Current	$I_R$	$V_{RWM} = 5.0\text{V}$			0.5	$\mu\text{A}$
Clamping Voltage	$V_C$	$I_{PP} = 1\text{A}$ (8 x 20 $\mu\text{s}$ pulse)			9	V
Clamping Voltage	$V_C$	$I_{PP} = 4\text{A}$ (8 x 20 $\mu\text{s}$ pulse)			15	V
Junction Capacitance	$C_J$	$V_R = 0\text{V}$ , $f = 1\text{MHz}$		0.4	0.6	pF

**Portion Electronics Parameter**

Symbol	Parameter
$I_T$	Test Current
$I_{PP}$	Maximum Reverse Peak Pulse Current
$V_C$	Clamping Voltage @ $I_C$

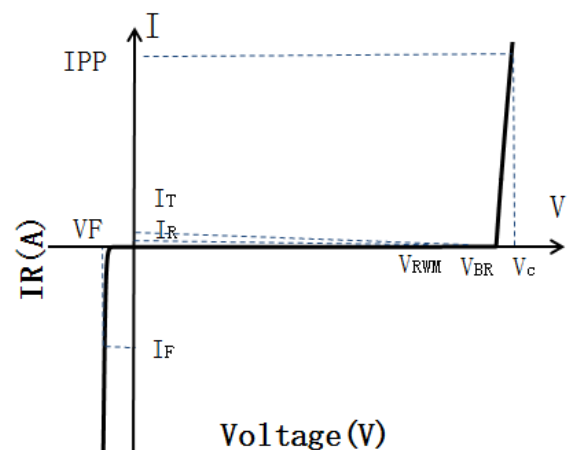

Typical Performance Characteristics ( $T_A=25^{\circ}\text{C}$  unless otherwise Specified)

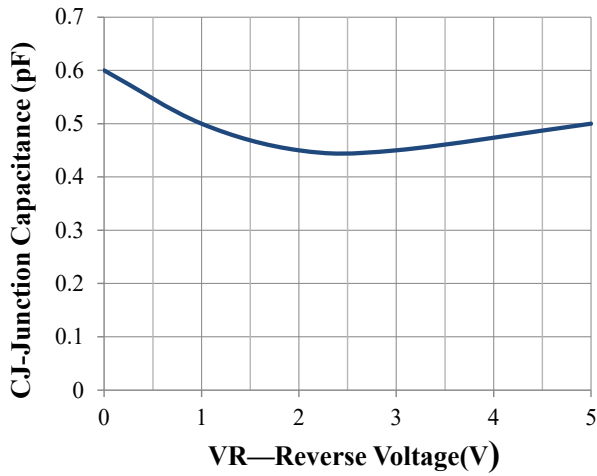

Junction Capacitance vs. Reverse Voltage

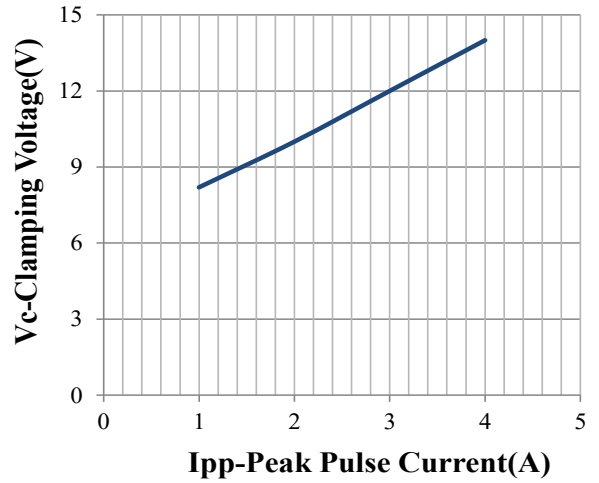

Clamping Voltage vs. Peak Pulse Current

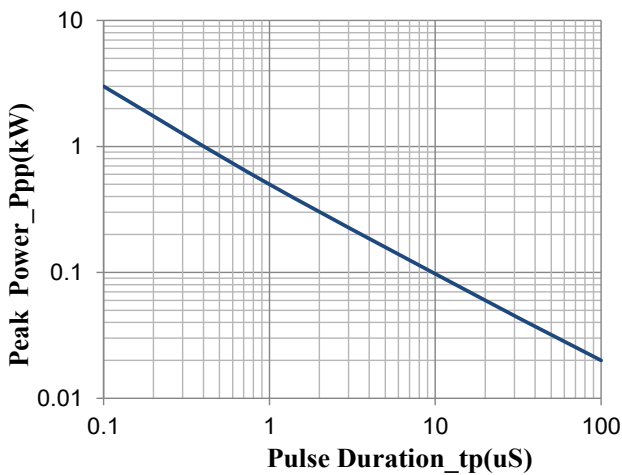

Peak Pulse Power vs. Pulse Time

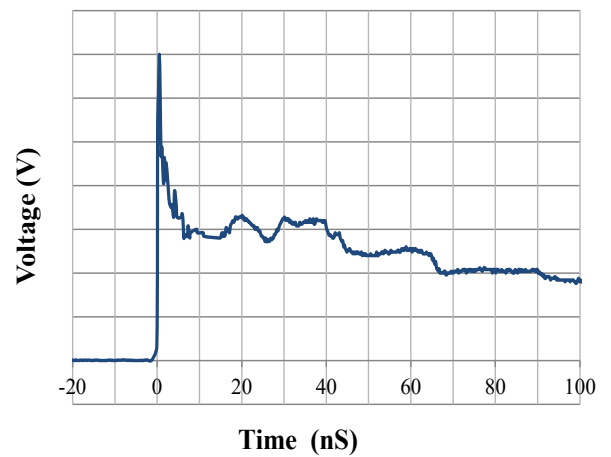

IEC61000-4-2 Pulse Waveform

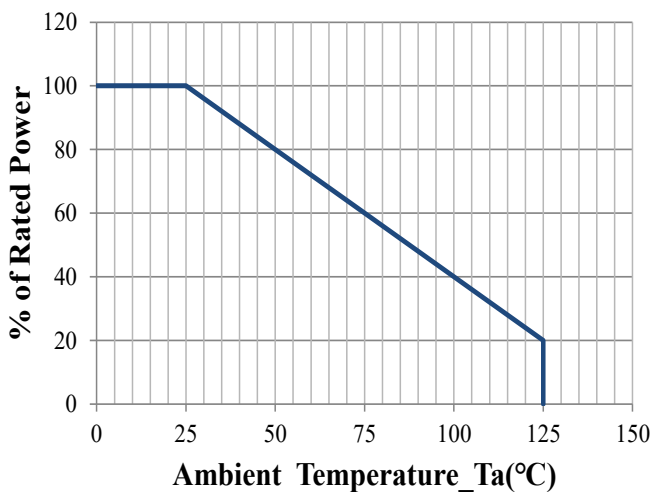

Power Derating Curve

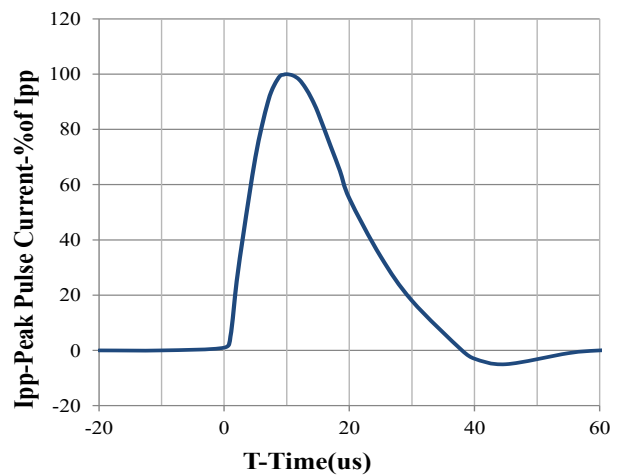

8 X 20us Pulse Waveform

## JE05U4RD40-10 on VGA Port Application

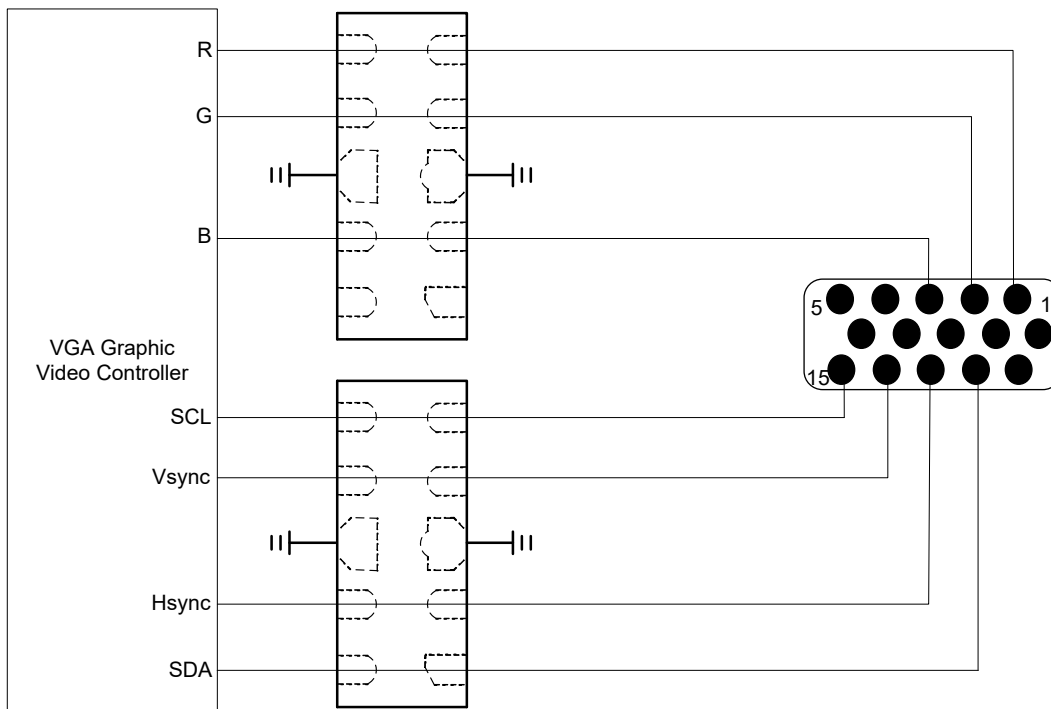

## JE05U4RD40-10 on eSATA Port Application

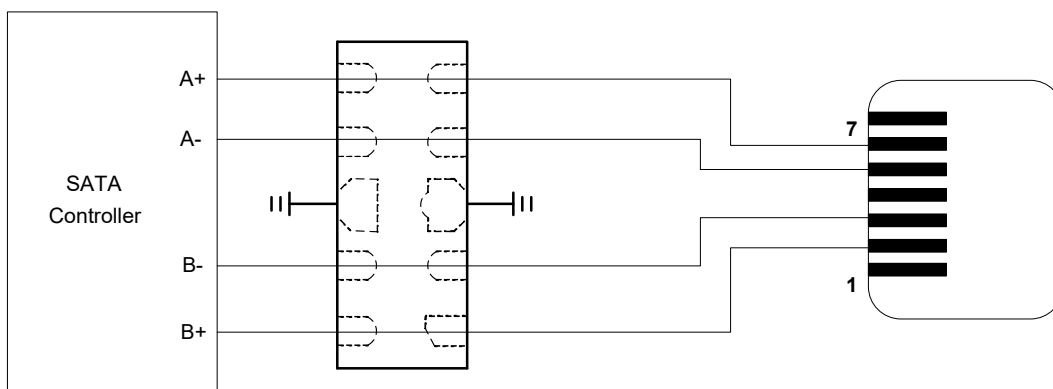

### DFN2510-10 Package Outline Drawing

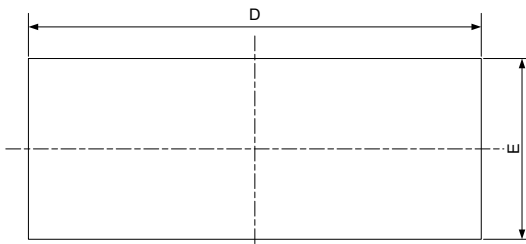

TOP VIEW

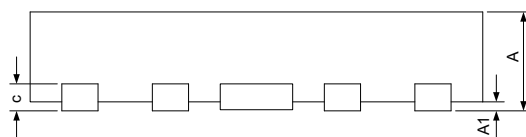

SIDE VIEW

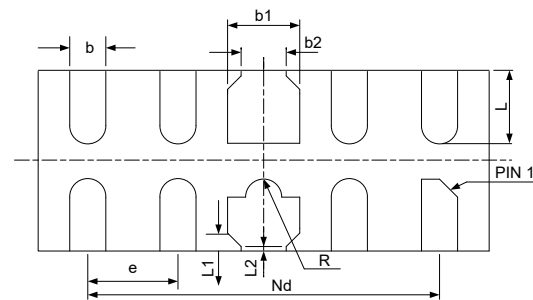

BOTTOM VIEW

SYM	DIMENSIONS					
	MILLIMETERS			INCHES		
	MIN	NOM	MAX	MIN	NOM	MAX
A	0.45	0.50	0.55	0.018	0.020	0.022
A1	0.00	0.02	0.05	0.000	0.001	0.002
b	0.15	0.20	0.25	0.006	0.008	0.010
b1	0.35	0.40	0.45	0.014	0.016	0.018
b2	0.20	0.25	0.30	0.008	0.010	0.012
c	0.10	0.15	0.20	0.004	0.006	0.008
D	2.45	2.50	2.55	0.098	0.100	0.102
e	0.50BSC			0.020BSC		
Nd	2.00BSC			0.080BSC		
E	0.95	1.00	1.05	0.038	0.040	0.042
L	0.35	0.40	0.45	0.014	0.016	0.018
L1	0.075REF			0.003REF		
L2	0.050REF			0.002REF		
h	0.08	0.12	0.15	0.003	0.005	0.006
R	0.05	0.10	0.15	0.002	0.004	0.006

### Suggested Land Pattern

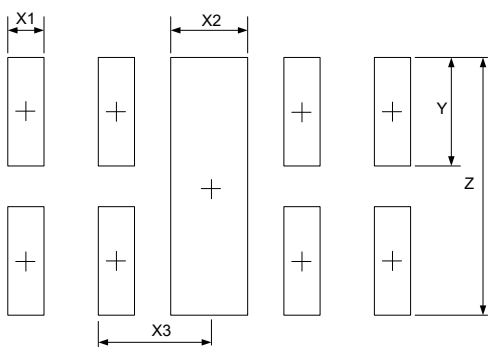

SYM	DIMENSIONS	
	MILLIMETERS	INCHES
X1	0.200	0.008
X2	0.400	0.016
X3	0.500	0.020
Y	0.600	0.024
Z	1.400	0.056

### NOTICE

Jelan-Link reserves the right to make changes without further notice to any products here in.

Only obligations are those in the Jelan-Link Standard Terms and Conditions of Sale and in no case will Jelan-Link be liable for any incidental, indirect, or consequential damages arising from the sale, resale, use, or misuse of its products.