

## Description

The JE24U1LD20-2 is a Uni-directional TVS diode, utilizing leading monolithic silicon technology to provide fast response time and low ESD clamping voltage, making this device an ideal solution for protecting voltage sensitive data and power line. The JE24U1LD20-2 complies with the IEC 61000-4-2 (ESD) with  $\pm 30\text{kV}$  air and  $\pm 30\text{kV}$  contact discharge. It is assembled into an ultra-small 1.0x0.6x0.5mm lead-free DFN package. The small size and high ESD surge protection make JE24U1LD20-2 an ideal choice to protect cell phone, digital cameras, audio players and many other portable applications.

## Features

- \* 220W peak pulse power (8/20 $\mu\text{s}$ )
- \* Low leakage:nA level
- \* Operating voltage: 24V
- \* Low clamping voltage
- \* One power line protects
- \* Complies with following standards:
  - IEC 61000-4-2 (ESD) immunity test
    - Air discharge:  $\pm 30\text{kV}$
    - Contact discharge:  $\pm 30\text{kV}$
  - IEC61000-4-5 (Lightning) 5A (8/20 $\mu\text{s}$ )
- \* RoHS Compliant
- \* Package: DFN1006-2

## Circuit Diagram

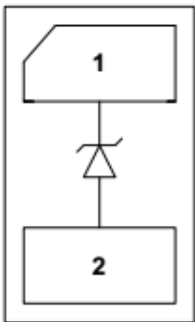

Circuit and Pin Schematic

## Applications

- \* Cellular Handsets and Accessories
- \* Personal Digital Assistants
- \* Notebooks and Handhelds
- \* Portable Instrumentation
- \* Digital Cameras
- \* Peripherals
- \* Audio Players
- \* Keypads, Side Keys, LCD Displays

## Ordering Information

Part Number	Packaging	Reel Size
JE24U1LD20-2	10000/Tape & Reel	7 inch

## Marking Diagram

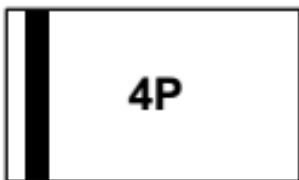

Transparent top view

4P: Device Marking Code

**Absolute Maximum Ratings ( $T_A=25^{\circ}\text{C}$  unless otherwise specified)**

Parameter	Symbol	Value	Unit
Peak Pulse Power (8/20 $\mu\text{s}$ )	Ppk	220	W
Peak Pulse Current (8/20 $\mu\text{s}$ )	IPP	5	A
ESD per IEC 61000-4-2 (Air)	VESD	$\pm 30$	kV
ESD per IEC 61000-4-2 (Contact)		$\pm 30$	
Operating Temperature Range	TJ	-55to +125	$^{\circ}\text{C}$
Storage Temperature Range	Tstg	-55 to +150	$^{\circ}\text{C}$

**Electrical Characteristics ( $T_A=25^{\circ}\text{C}$  unless otherwise specified)**

Parameter	Symbol	Test Condition	Min	Typ	Max	Unit
Reverse Working Voltage	$V_{RWM}$				24	V
Breakdown Voltage	$V_{BR}$	$I_T = 1\text{mA}$	27			V
Reverse Leakage Current	$I_R$	$V_{RWM} = 24\text{V}$			0.2	$\mu\text{A}$
Clamping Voltage	$V_C$	$I_{PP} = 1\text{A}$ (8 x 20 $\mu\text{s}$ pulse)			33	V
Clamping Voltage	$V_C$	$I_{PP} = 5\text{A}$ (8 x 20 $\mu\text{s}$ pulse)			44	V
Junction Capacitance	$C_J$	$V_R = 0\text{V}$ , $f = 1\text{MHz}$			40	pF

**Portion Electronics Parameter**

Symbol	Parameter
$I_T$	Test Current
$I_{PP}$	Maximum Reverse Peak Pulse Current
$V_C$	Clamping Voltage @ $I_C$

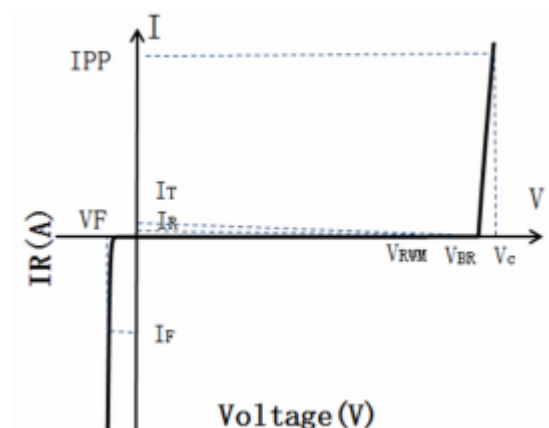

Typical Performance Characteristics ( $T_A=25^{\circ}\text{C}$  unless otherwise Specified)

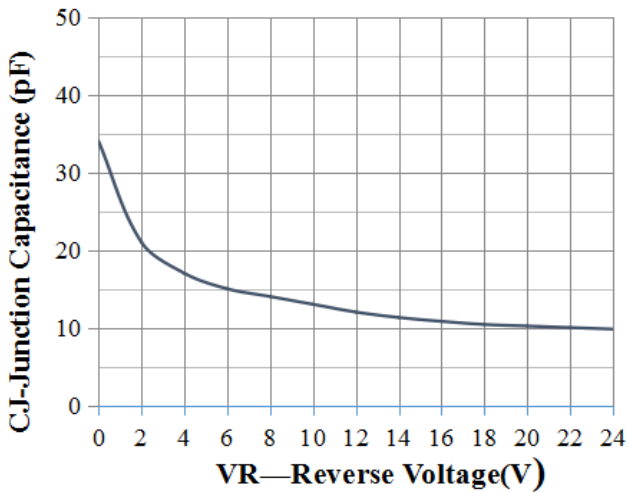

Junction Capacitance vs. Reverse Voltage

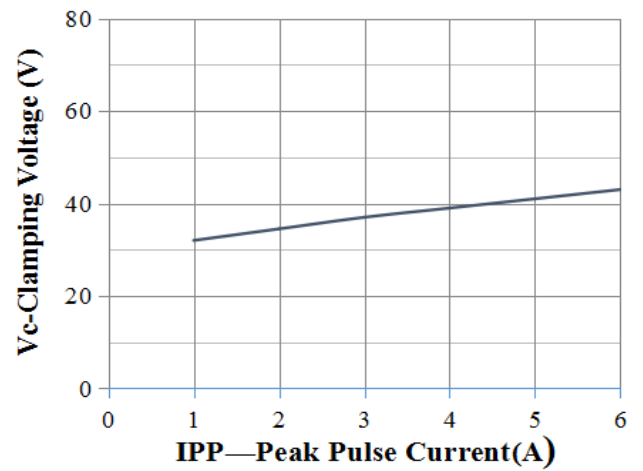

Clamping Voltage vs. Peak Pulse Current

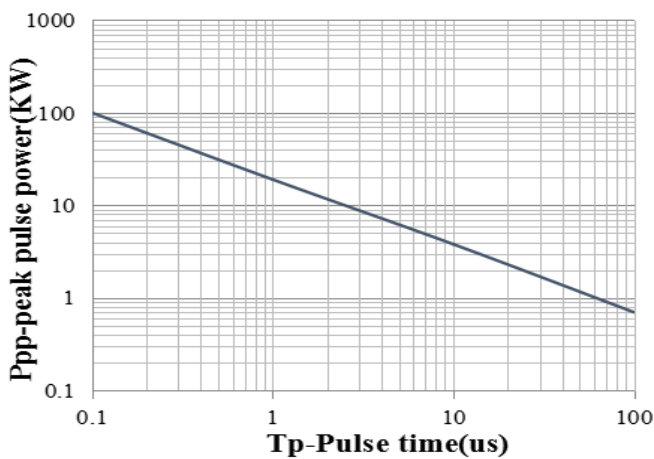

Peak Pulse Power vs. Pulse Time

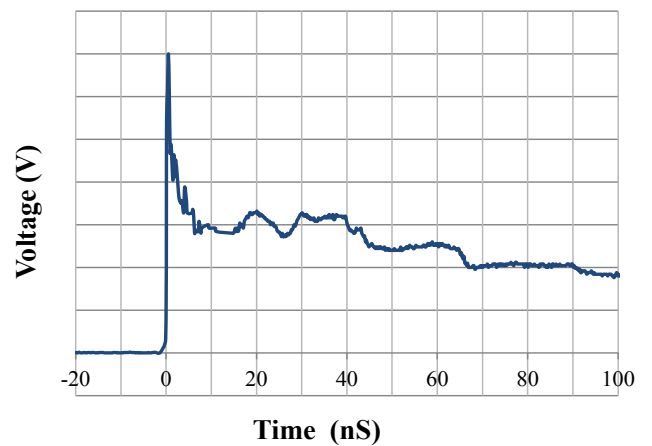

IEC61000-4-2 Pulse Waveform

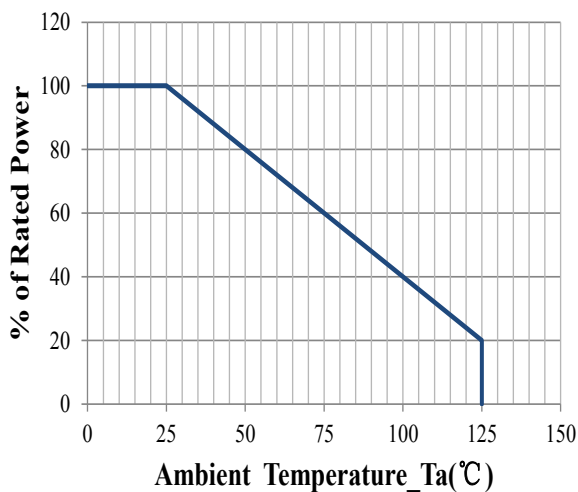

Power Derating Curve

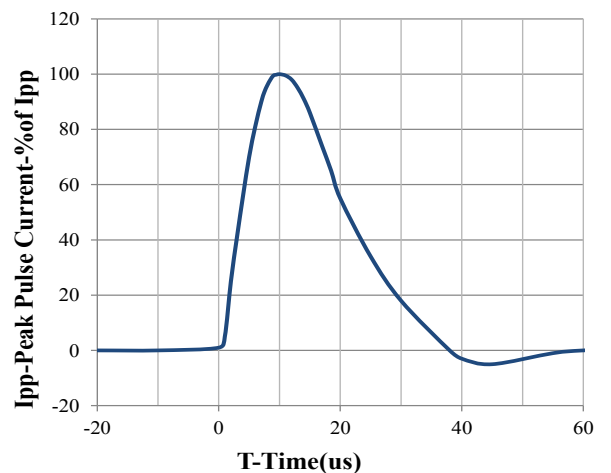

8 X 20us Pulse Waveform

**DFN1006-2 Package Outline Drawing** (Dimensions in millimeters)

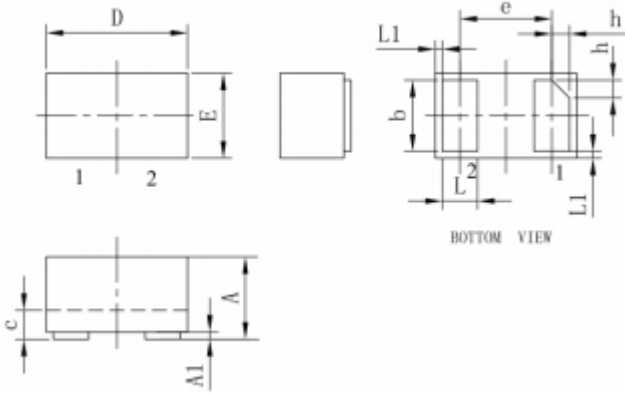

SYM	DIMENSIONS					
	MILLIMETERS			INCHES		
	MIN	NOM	MAX	MIN	NOM	MAX
A	0.45	0.50	0.55	0.018	0.020	0.022
A1	0.00	0.02	0.05	0.000	0.001	0.002
b	0.45	0.50	0.55	0.018	0.020	0.022
c	0.12	0.15	0.18	0.005	0.006	0.007
D	0.95	1.00	1.05	0.037	0.039	0.041
e	0.65 BSC			0.026 BSC		
E	0.55	0.60	0.65	0.022	0.024	0.026
L	0.20	0.25	0.30	0.008	0.010	0.012
L1	0.05REF			0.002REF		
h	0.07	0.12	0.17	0.003	0.005	0.007

**Suggested Land Pattern**

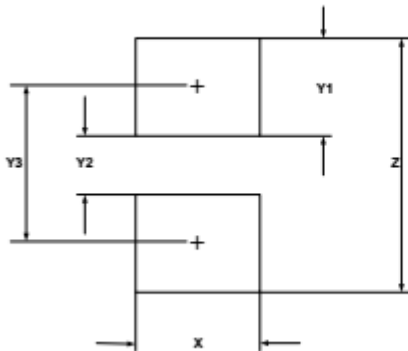

SYM	DIMENSIONS	
	MILLIMETERS	INCHES
X	0.60	0.024
Y1	0.50	0.020
Y2	0.30	0.012
Y3	0.80	0.032
Z	1.30	0.052

**NOTICE**

Jelan-Link reserves the right to make changes without further notice to any products here in.

Only obligations are those in the Jelan-Link Standard Terms and Conditions of Sale and in no case will Jelan-Link be liable for any incidental, indirect, or consequential damages arising from the sale, resale, use, or misuse of its products.