

# JE18B1RD20-2

## 1-Line Ultra Low Capacitance Bi-directional TVS Diode



### Description

The JE18B1RD20-2 is a bi-directional TVS diode, utilizing leading monolithic silicon technology to provide fast response time and low ESD clamping voltage, making this device an ideal solution for protecting voltage sensitive high-speed data lines. The JE18B1RD20-2 has an ultra-low capacitance with a typical value at 0.3pF, and complies with the IEC 61000-4-2 (ESD) with  $\pm 25\text{kV}$  air and  $\pm 15\text{kV}$  contact discharge. It is assembled into an ultra-small 1.0x0.6x0.5mm lead-free DFN package. The small size, ultra-low capacitance and high ESD surge protection make JE18B1RD20-2 an ideal choice to protect cell phone, digital visual interfaces and other high speed ports.

### Circuit Diagram

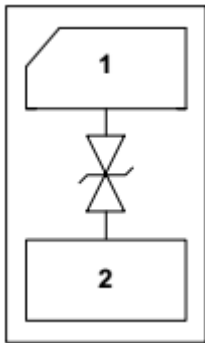

Circuit and Pin Schematic

### Marking Diagram



Transparent top view

R18:Device Marking Code

### Features

- \* 80W peak pulse power (8/20 $\mu\text{s}$ )
- \* Low leakage:nA level
- \* Operating voltage: 3.3V
- \* Low clamping voltage
- \* One power line protects
- \* Complies with following standards:
  - IEC 61000-4-2 (ESD) immunity test
  - Air discharge:  $\pm 25\text{kV}$
  - Contact discharge:  $\pm 15\text{kV}$
  - IEC61000-4-5 (Lightning) 2A (8/20 $\mu\text{s}$ )
- \* RoHS Compliant
- \* Package:DFN1006-2

### Applications

- \* Antenna
- \* Cellular Handsets and Accessories
- \* Display Ports
- \* Digital Visual Interfaces(DVI)
- \* PCI Express and Serial SATA Ports
- \* Digital Cameras

### Ordering Information

Part Number	Packaging	Reel Size
JE18B1RD20-2	10000/Tape & Reel	7 inch

**Absolute Maximum Ratings ( $T_A=25^{\circ}\text{C}$  unless otherwise specified)**

Parameter	Symbol	Value	Unit
Peak Pulse Power (8/20 $\mu\text{s}$ )	Ppk	80	W
Peak Pulse Current (8/20 $\mu\text{s}$ )	IPP	2	A
ESD per IEC 61000-4-2 (Air)	VESD	$\pm 25$	kV
ESD per IEC 61000-4-2 (Contact)		$\pm 15$	
Operating Temperature Range	TJ	-55to +125	$^{\circ}\text{C}$
Storage Temperature Range	Tstg	-55 to +150	$^{\circ}\text{C}$

**Electrical Characteristics ( $T_A=25^{\circ}\text{C}$  unless otherwise specified)**

Parameter	Symbol	Test Condition	Min	Typ	Max	Unit
Reverse Working Voltage	$V_{RWM}$				18	V
Breakdown Voltage	$V_{BR}$	$I_T = 1\text{mA}$	19.5			V
Reverse Leakage Current	$I_R$	$V_{RWM} = 18\text{V}$			0.2	$\mu\text{A}$
Clamping Voltage	$V_C$	$I_{PP} = 2\text{A}$ (8 x 20 $\mu\text{s}$ pulse)			40	V
Junction Capacitance	$C_J$	$V_R = 0\text{V}$ , $f = 1\text{MHz}$ ,)		0.3		pF

**Portion Electronics Parameter**

Symbol	Parameter
$I_T$	Test Current
$I_{PP}$	Maximum Reverse Peak Pulse Current
$V_C$	Clamping Voltage @ $I_C$

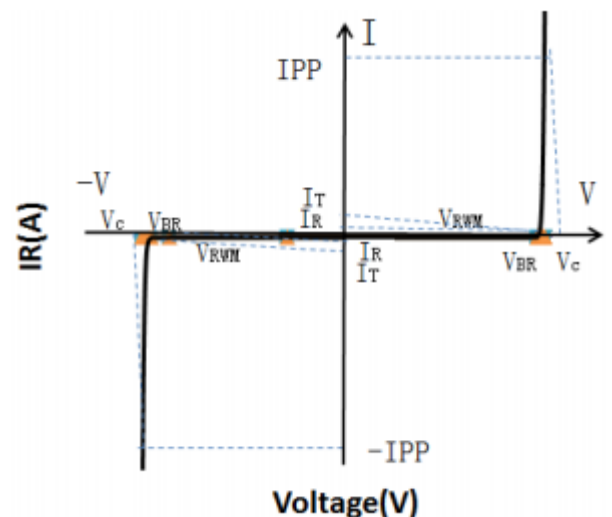

Typical Performance Characteristics ( $T_A=25^{\circ}\text{C}$  unless otherwise Specified)

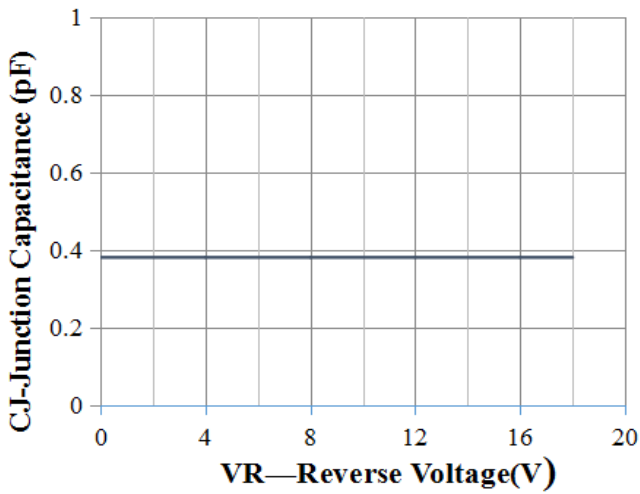

Junction Capacitance vs. Reverse Voltage

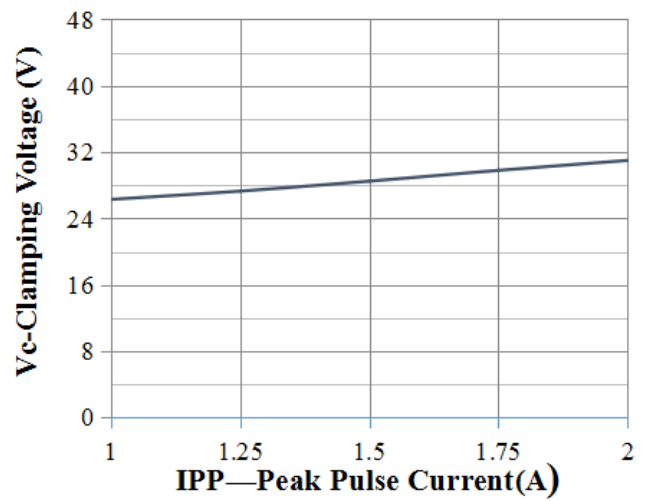

Clamping Voltage vs. Peak Pulse Current

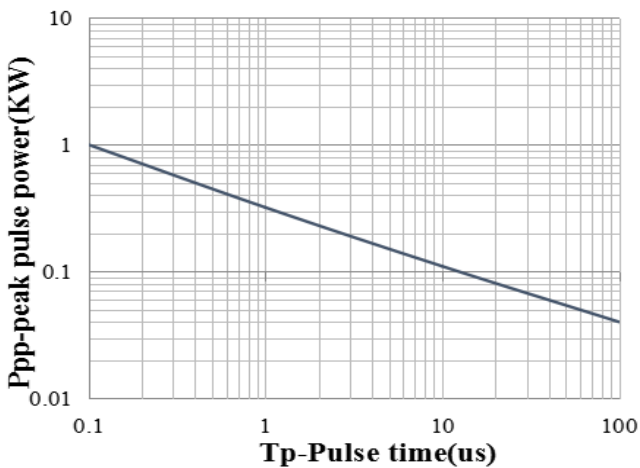

Peak Pulse Power vs. Pulse Time

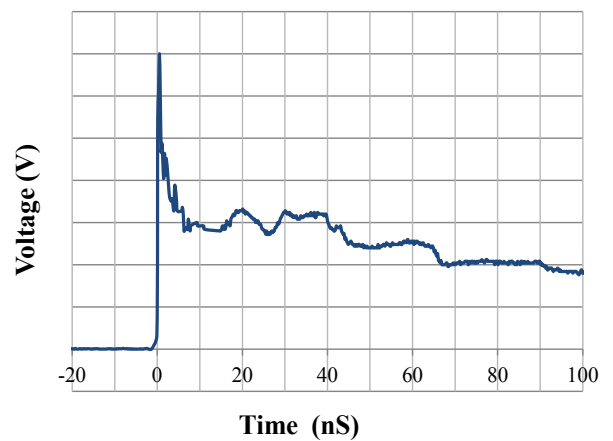

IEC61000-4-2 Pulse Waveform

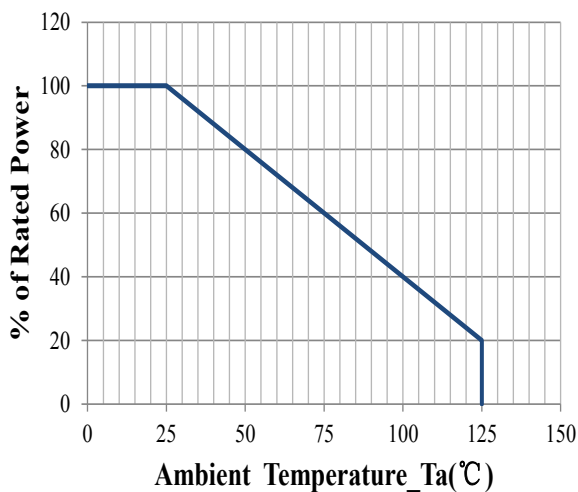

Power Derating Curve

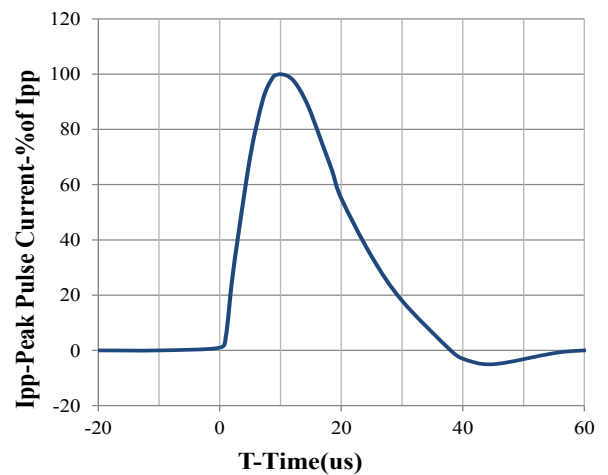

8 X 20us Pulse Waveform

**DFN1006-2 Package Outline Drawing** (Dimensions in millimeters)

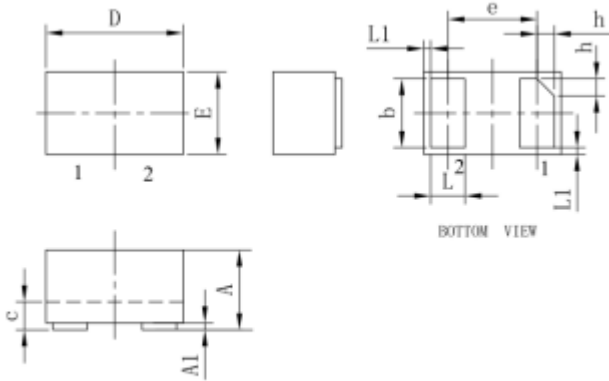

SYM	DIMENSIONS					
	MILLIMETERS			INCHES		
	MIN	NOM	MAX	MIN	NOM	MAX
A	0.45	0.50	0.55	0.018	0.020	0.022
A1	0.00	0.02	0.05	0.000	0.001	0.002
b	0.45	0.50	0.55	0.018	0.020	0.022
c	0.12	0.15	0.18	0.005	0.006	0.007
D	0.95	1.00	1.05	0.037	0.039	0.041
e	0.65 BSC			0.026 BSC		
E	0.55	0.60	0.65	0.022	0.024	0.026
L	0.20	0.25	0.30	0.008	0.010	0.012
L1	0.05REF			0.002REF		
h	0.07	0.12	0.17	0.003	0.005	0.007

**Suggested Land Pattern**

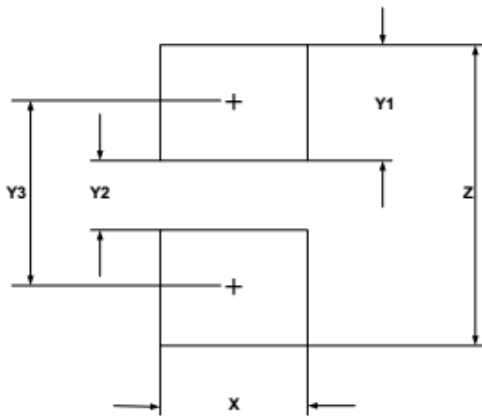

SYM	DIMENSIONS	
	MILLIMETERS	INCHES
X	0.60	0.024
Y1	0.50	0.020
Y2	0.30	0.012
Y3	0.80	0.032
Z	1.30	0.052

**NOTICE**

Jelan-Link reserves the right to make changes without further notice to any products here in.

Only obligations are those in the Jelan-Link Standard Terms and Conditions of Sale and in no case will Jelan-Link be liable for any incidental, indirect, or consequential damages arising from the sale, resale, use, or misuse of its products.