

JE15B1RS30-2

1-Line Bi-directional TVS Diode



Description

The JE15B1RS30-2 is a 15V bi-directional TVS diode, utilizing leading monolithic silicon technology to provide fast response time and low ESD clamping voltage, making this device an ideal solution for protecting voltage sensitive high-speed data lines. The JE15B1RS30-2 has a low capacitance with a typical value at 1pF, and complies with the IEC 61000-4-2 (ESD) with $\pm 30\text{kV}$ air and $\pm 30\text{kV}$ contact discharge. It is assembled into a lead-free SOD-323 package. The small size, low capacitance and high ESD surge protection make JE15B1RS30-2 an ideal choice to protect cell phone, wireless systems, and communication equipment.

Circuit Diagram

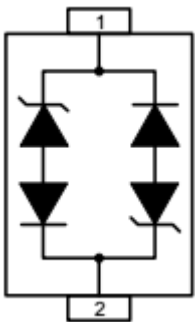

Circuit and Pin Schematic

Marking Diagram



Transparent top view

R15: Device Marking Code

Features

- * 300W peak pulse power (8/20 μs)
- * Ultra Low leakage: nA level
- * Operating voltage: 15V
- * Low clamping voltage
- * One power line protects
- * Complies with following standards:
 - IEC 61000-4-2 (ESD) immunity test
 - Air discharge: $\pm 30\text{kV}$
 - Contact discharge: $\pm 30\text{kV}$
 - IEC61000-4-5 (Lightning) 10A (8/20 μs)
- * RoHS Compliant
- * Package: SOD-323

Applications

- * USB Ports
- * Smart Phones
- * Wireless Systems
- * Ethernet 10/100/1000 Base T

Ordering Information

Part Number	Packaging	Reel Size
JE15B1RS30-2	3000/Tape & Reel	7 inch

Absolute Maximum Ratings ($T_A=25^{\circ}\text{C}$ unless otherwise specified)

Parameter	Symbol	Value	Unit
Peak Pulse Power (8/20 μs)	Ppk	300	W
Peak Pulse Current (8/20 μs)	IPP	10	A
ESD per IEC 61000-4-2 (Air)	VESD	± 30	kV
ESD per IEC 61000-4-2 (Contact)		± 30	
Operating Temperature Range	TJ	-40to +85	$^{\circ}\text{C}$
Storage Temperature Range	Tstg	-55 to +150	$^{\circ}\text{C}$

Electrical Characteristics ($T_A=25^{\circ}\text{C}$ unless otherwise specified)

Parameter	Symbol	Test Condition	Min	Typ	Max	Unit
Reverse Working Voltage	V_{RWM}				15	V
Breakdown Voltage	V_{BR}	$I_T = 1\text{mA}$	16.7			V
Reverse Leakage Current	I_R	$V_{RWM} = 15\text{V}$			0.2	μA
Clamping Voltage	V_C	$I_{PP} = 1\text{A}$ (8 x 20 μs pulse)			21	V
Clamping Voltage	V_C	$I_{PP} = 10\text{A}$ (8 x 20 μs pulse)			30	V
Junction Capacitance	C_J	$V_R = 0\text{V}$, $f = 1\text{MHz}$,)		1		pF

Portion Electronics Parameter

Symbol	Parameter
I_T	Test Current
I_{PP}	Maximum Reverse Peak Pulse Current
V_C	Clamping Voltage @ I_C

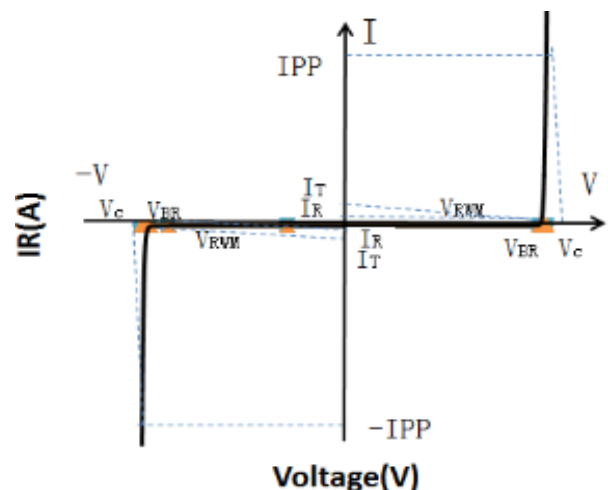

Typical Performance Characteristics ($T_A=25^{\circ}\text{C}$ unless otherwise Specified)

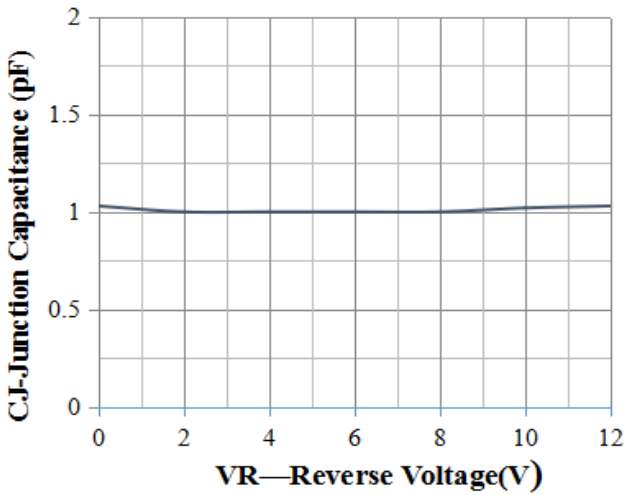

Junction Capacitance vs. Reverse Voltage

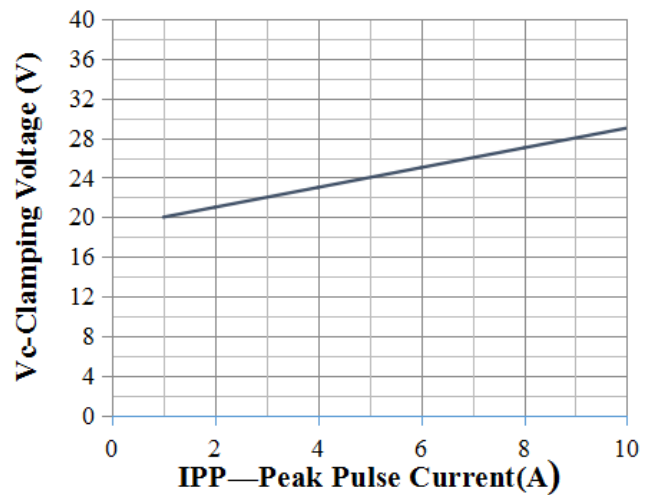

Clamping Voltage vs. Peak Pulse Current

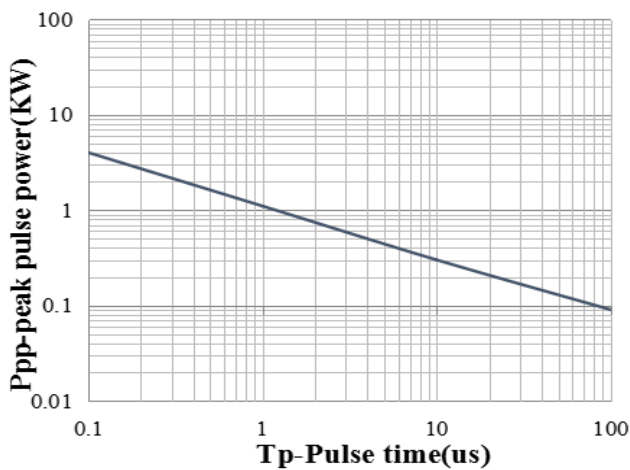

Peak Pulse Power vs. Pulse Time

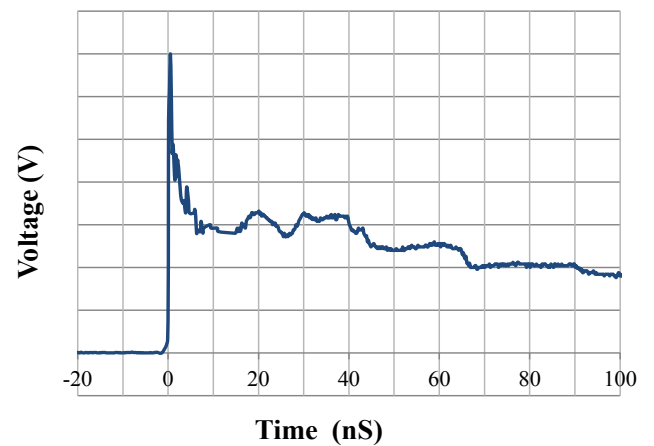

IEC61000-4-2 Pulse Waveform

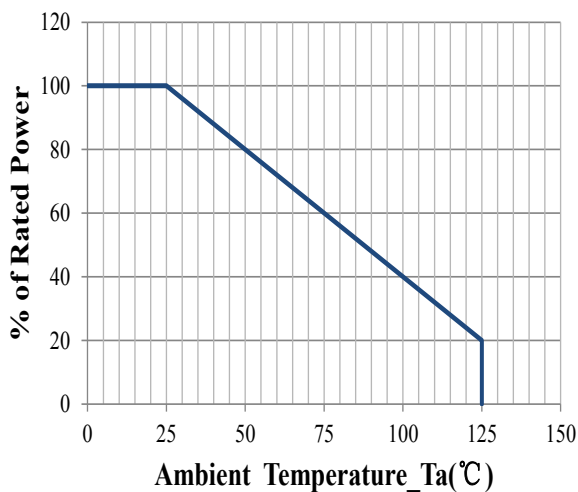

Power Derating Curve

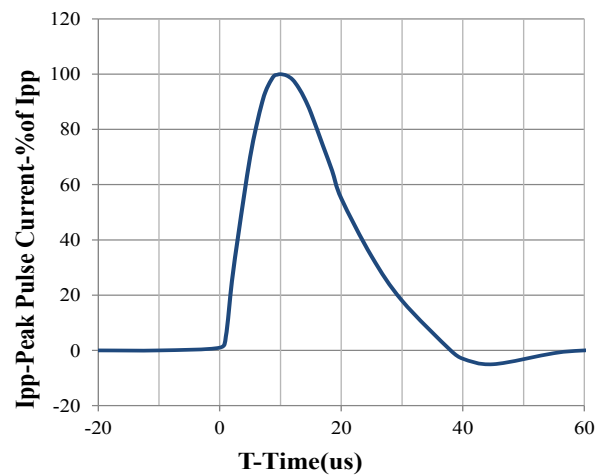

8 X 20us Pulse Waveform

JE15B1RS30-2

SOD-323 Package Outline Drawing (Dimensions in millimeters)

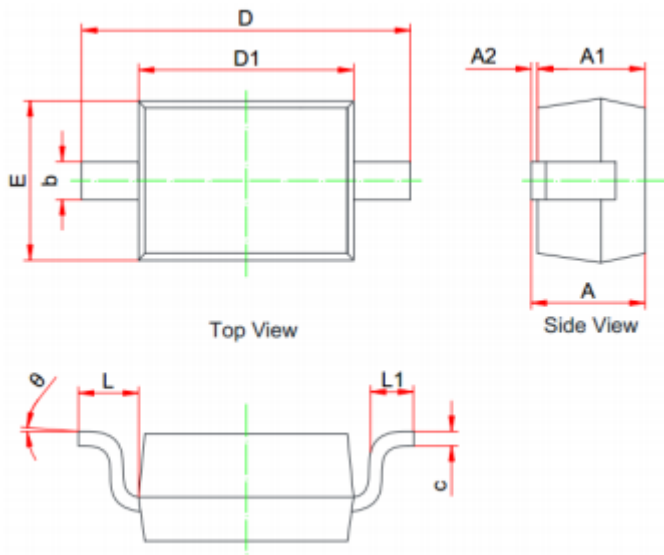

SYM	MILLIMETERS		
	MIN	NOM	MAX
A	0.800	--	1.100
A1	0.800	--	0.900
A2	0.000	--	0.100
b	0.250	--	0.400
c	0.080	--	0.177
D1	1.600	1.700	1.800
D	2.300	--	2.800
E	1.150	--	1.400
L	0.475REF		
L1	0.100	--	0.500
Θ	0°	--	8°

Suggested Land Pattern



Unit: mm

NOTICE

Jelan-Link reserves the right to make changes without further notice to any products here in.

Only obligations are those in the Jelan-Link Standard Terms and Conditions of Sale and in no case will Jelan-Link be liable for any incidental, indirect, or consequential damages arising from the sale, resale, use, or misuse of its products.