

JE05B1US50-2

1-Line Bi-directional TVS Diode



Description

The JE05B1US50-2 is a bi-directional TVS diode, utilizing leading monolithic silicon technology to provide fast response time and low ESD clamping voltage, making this device an ideal solution for protecting voltage sensitive data and power line. The JE05B1US50-2 complies with the IEC 61000-4-2 (ESD) standard with ± 30 kV air and ± 30 kV contact discharge. It is assembled into an ultra-small lead-free SOD-523 package. The small size and high ESD surge protection make JE05B1US50-2 an ideal choice to protect cell phone, digital cameras, audio players and many other portable applications.

Circuit Diagram

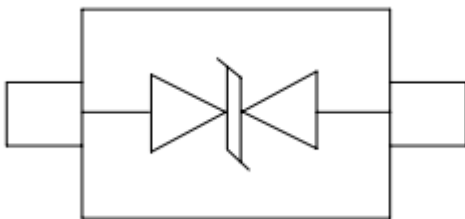

Circuit and Pin Schematic

Marking Diagram

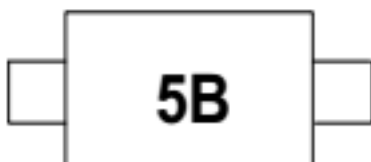

Transparent top view

5B: Device Marking Code

Features

- * 100W peak pulse power (8/20 μ s)
- * Low leakage: nA level
- * Operating voltage: 5V
- * Ultra low clamping voltage
- * One power line protects
- * Complies with following standards:
 - IEC 61000-4-2 (ESD) immunity test
 - Air discharge: ± 30 kV
 - Contact discharge: ± 30 kV
 - IEC61000-4-5 (Lightning) 8A (8/20 μ s)
- * RoHS Compliant
- * Package: SOD-523

Applications

- * Cellular Handsets and Accessories
- * Personal Digital Assistants
- * Notebooks and Handhelds
- * Digital Cameras
- * Peripherals
- * Audio Players
- * Keypads, Side Keys, LCD Displays

Ordering Information

Part Number	Packaging	Reel Size
JE05B1US50-2	3000/Tape & Reel	7 inch

Absolute Maximum Ratings ($T_A=25^{\circ}\text{C}$ unless otherwise specified)

Parameter	Symbol	Value	Unit
Peak Pulse Power (8/20 μs)	Ppk	100	W
Peak Pulse Current (8/20 μs)	IPP	8	A
ESD per IEC 61000-4-2 (Air)	VESD	± 30	kV
ESD per IEC 61000-4-2 (Contact)		± 30	
Operating Temperature Range	TJ	-55 to +125	$^{\circ}\text{C}$
Storage Temperature Range	Tstg	-55 to +150	$^{\circ}\text{C}$

Electrical Characteristics ($T_A=25^{\circ}\text{C}$ unless otherwise specified)

Parameter	Symbol	Test Condition	Min	Typ	Max	Unit
Reverse Working Voltage	V_{RWM}				5	V
Breakdown Voltage	V_{BR}	$I_T = 1\text{mA}$	6		8	V
Reverse Leakage Current	I_R	$V_{RWM} = 5\text{V}$			0.2	μA
Clamping Voltage	V_C	$I_{PP} = 1\text{A}$ (8 x 20 μs pulse)			8	V
Clamping Voltage	V_C	$I_{PP} = 8\text{A}$ (8 x 20 μs pulse)			12.5	V
Junction Capacitance	C_J	$V_R = 0\text{V}$, $f = 1\text{MHz}$			20	pF

Symbol	Parameter
I_T	Test Current
I_{PP}	Maximum Reverse Peak Pulse Current
V_C	Clamping Voltage @ I_C

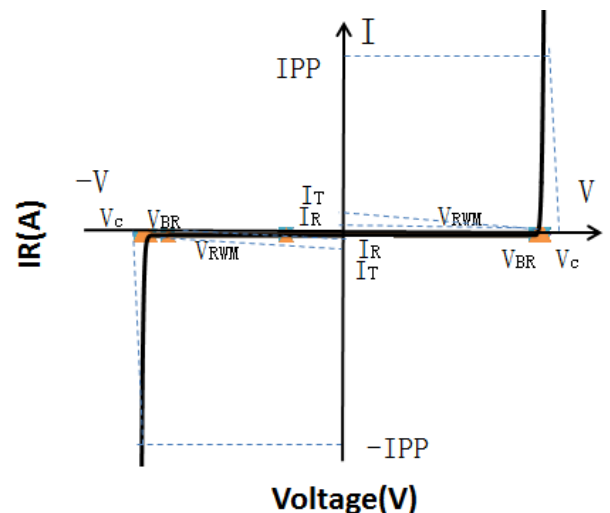

Portion Electronics Parameter

Typical Performance Characteristics ($T_A=25^{\circ}\text{C}$ unless otherwise Specified)

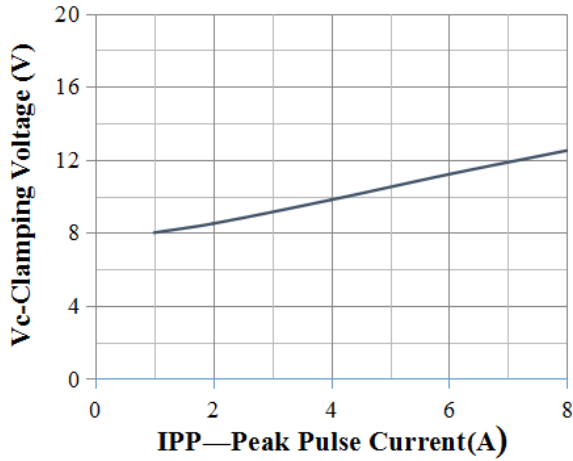

Junction Capacitance vs. Reverse Voltage

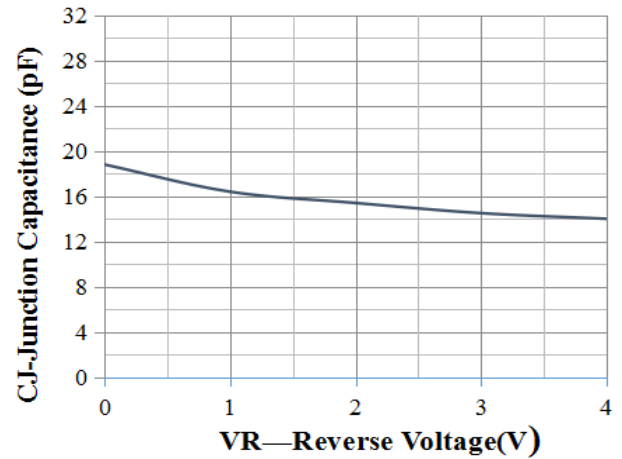

Clamping Voltage vs. Peak Pulse Current

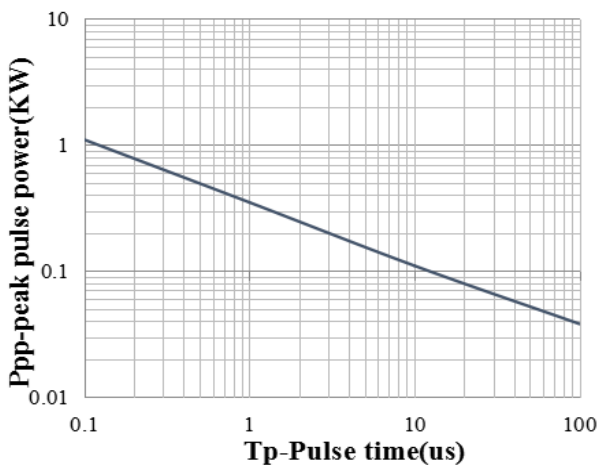

Peak Pulse Power vs. Pulse Time

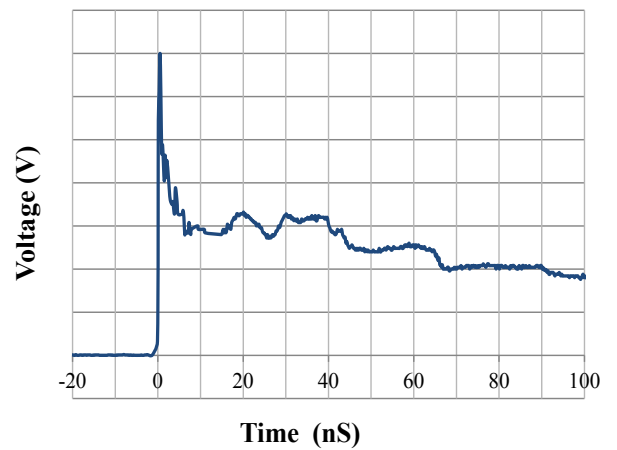

IEC61000-4-2 Pulse Waveform

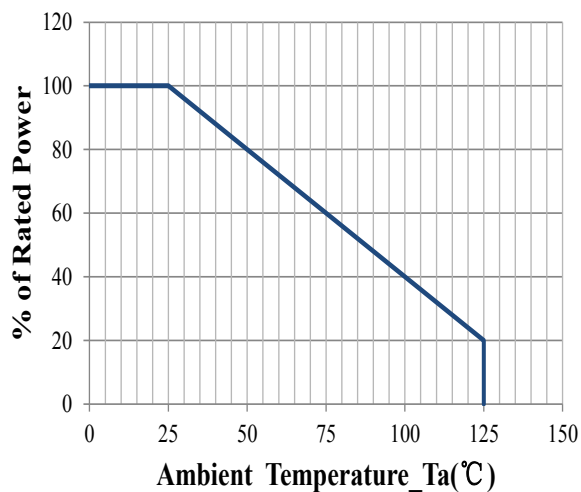

Power Derating Curve

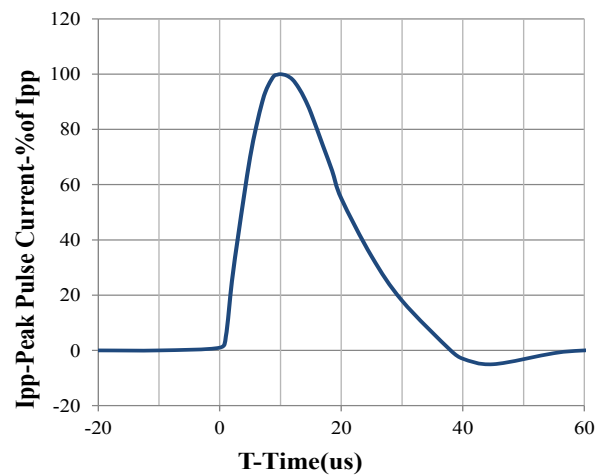

8 X 20us Pulse Waveform

SOD-523 Package Outline Drawing (Dimensions in millimeters)

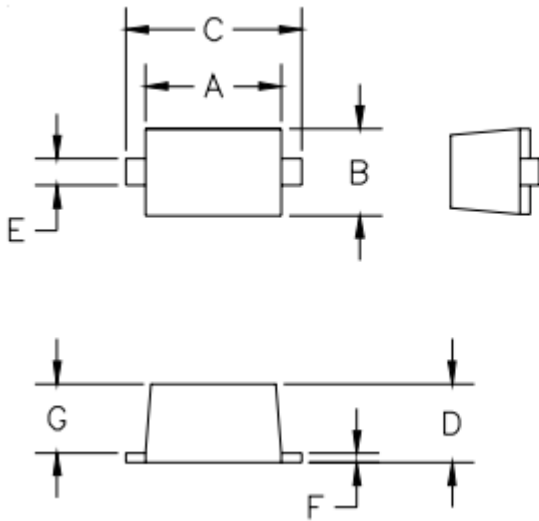

DIM ^N	INCHES		MM [1]		NOTE
	MIN	MAX	MIN	MAX	
A	.043	.051	1.10	1.30	-
B	.028	.035	0.70	0.90	-
C	.059	.067	1.50	1.70	-
D	.020	.028	0.50	0.70	-
E	.010	.014	0.25	0.35	-
F	.004	.008	0.10	0.20	-
G	.020	.028	0.50	0.70	-

Suggested Land Pattern

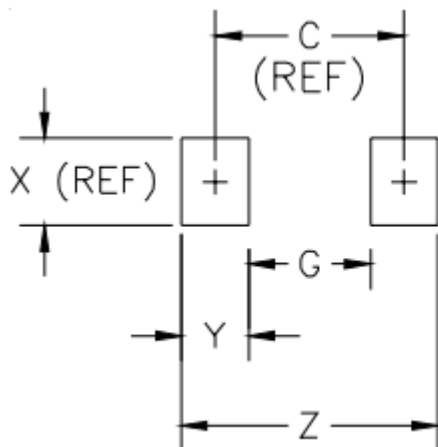

DIM ^N	INCHES		MM [1]		NOTE
	MIN	MAX	MIN	MAX	
C	-	.067	-	1.70	REF
G	-	.043	-	1.10	-
X	-	.031	-	0.80	REF
Y	-	.024	-	0.60	-
Z	-	.091	-	2.30	-

NOTICE

Jelan-Link reserves the right to make changes without further notice to any products here in.

Only obligations are those in the Jelan-Link Standard Terms and Conditions of Sale and in no case will Jelan-Link be liable for any incidental, indirect, or consequential damages arising from the sale, resale, use, or misuse of its products.