

Description

The JE07B1UD20-2 is a bi-directional TVS diode, utilizing leading monolithic silicon technology to provide fast response time and low ESD clamping voltage, making this device an ideal solution for protecting voltage sensitive data and power line. The JE07B1UD20-2 complies with the IEC 61000-4-2 (ESD) standard with ± 30 kV air and ± 30 kV contact discharge. It is assembled into an ultra-small 1.0x0.6x0.5mm lead-free 0402 package. The small size and high ESD surge protection make JE07B1UD20-2 an ideal choice to protect cell phone, digital cameras, audio players and many other portable applications.

Circuit Diagram

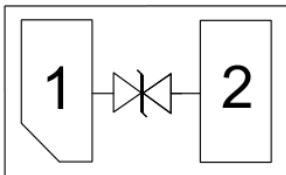

Circuit Diagram

Package Outline

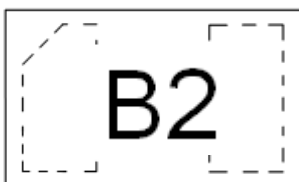

Transparent top view

B2: Device Marking Code

Features

- * Ultra low leakage: nA level
- * Operating voltage: 7V
- * Low clamping voltage
- * 2-pin leadless package
- * Complies with following standards:
 - IEC 61000-4-2 (ESD) immunity test
 - Air discharge: ± 30 kV
 - Contact discharge: ± 30 kV
 - IEC61000-4-5 (Lightning) 5A (8/20 μ s)
- * RoHS Compliant

Applications

- * Cellular Handsets and Accessories
- * Personal Digital Assistants
- * Notebooks and Handhelds
- * Portable Instrumentation
- * Digital Cameras
- * Peripherals
- * Audio Players

Ordering Information

Part Number	Packaging	Reel Size
JE07B1UD20-2	10000/Tape & Reel	7 inch

Absolute Maximum Ratings ($T_A=25^{\circ}\text{C}$ unless otherwise specified)

Parameter	Symbol	Value	Unit
Peak Pulse Power (8/20 μs)	Ppk	70	W
Peak Pulse Current (8/20 μs)	IPP	5	A
ESD per IEC 61000-4-2 (Air)	VESD	± 30	kV
ESD per IEC 61000-4-2 (Contact)		± 30	
Operating Temperature Range	TJ	-55 to +125	$^{\circ}\text{C}$
Storage Temperature Range	Tstg	-55 to +150	$^{\circ}\text{C}$

Electrical Characteristics ($T_A=25^{\circ}\text{C}$ unless otherwise specified)

Parameter	Symbol	Test Condition	Min	Typ	Max	Unit
Reverse Working Voltage	V_{RWM}				7.0	V
Breakdown Voltage	V_{BR}	$I_T = 1\text{mA}$	8.0	8.5		V
Reverse Leakage Current	I_R	$V_{RWM} = 5.0\text{V}$			0.5	μA
Clamping Voltage	V_C	$I_{PP} = 1\text{A}$ (8 x 20 μs pulse)			9	V
Clamping Voltage	V_C	$I_{PP} = 5\text{A}$ (8 x 20 μs pulse)		12.5	14	V
Junction Capacitance	C_J	$V_R = 0\text{V}$, $f = 1\text{MHz}$		10	15	pF

Portion Electronics Parameter

Symbol	Parameter
I_T	Test Current
I_{PP}	Maximum Reverse Peak Pulse Current
V_C	Clamping Voltage @ I_C

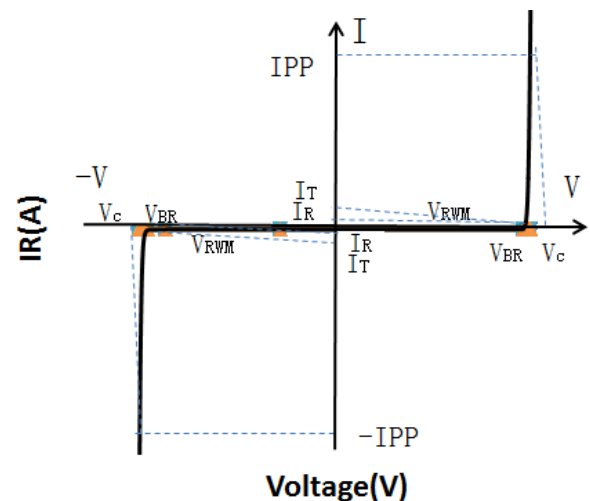

Typical Performance Characteristics ($T_A=25^{\circ}\text{C}$ unless otherwise Specified)

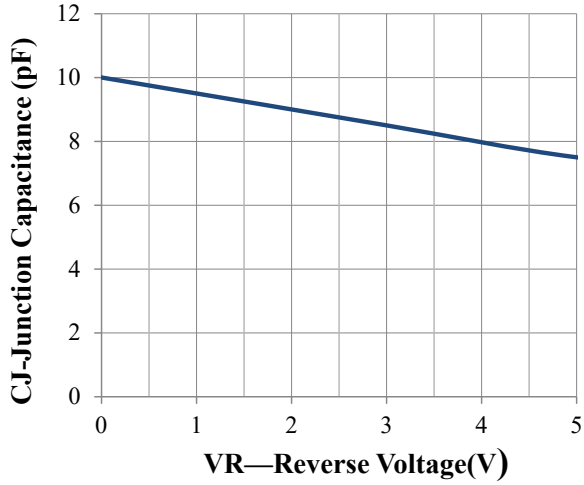

Junction Capacitance vs. Reverse Voltage

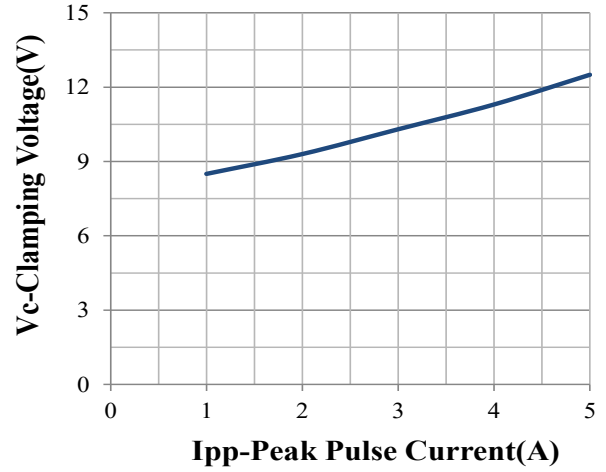

Clamping Voltage vs. Peak Pulse Current

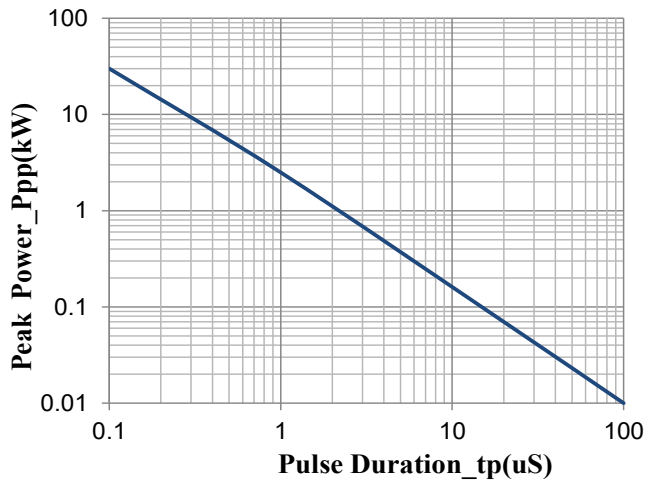

Peak Pulse Power vs. Pulse Time

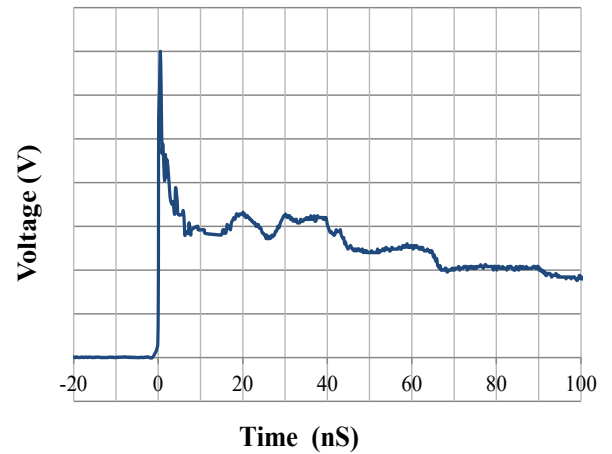

IEC61000-4-2 Pulse Waveform

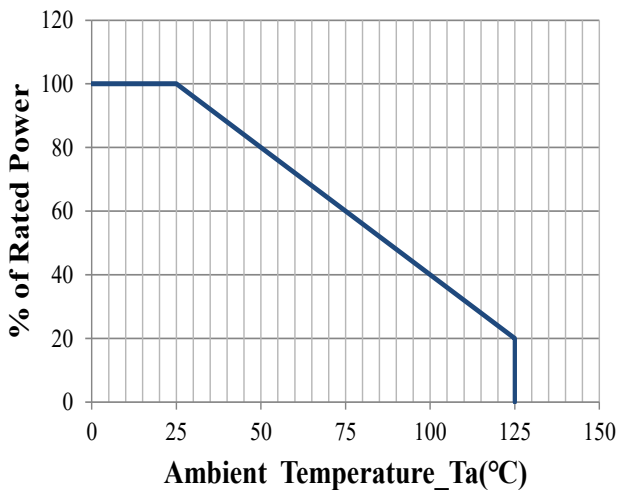

Power Derating Curve

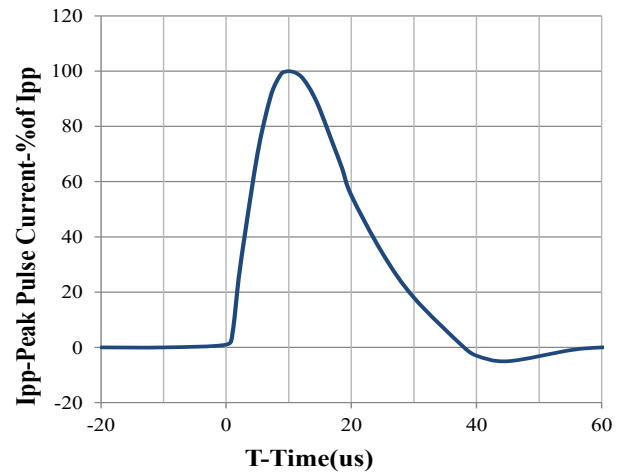

8 X 20us Pulse Waveform

DFN1006-2(0402) Package Outline Drawing

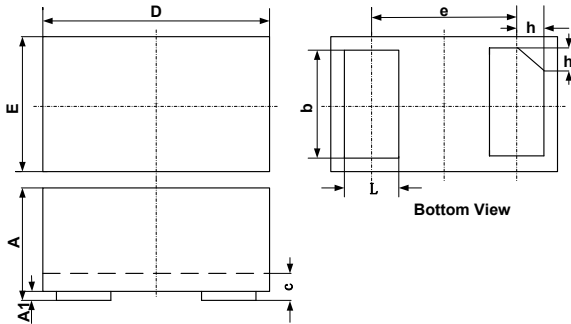

SYM	DIMENSIONS					
	MILLIMETERS			INCHES		
	MIN	NOM	MAX	MIN	NOM	MAX
A	0.45	0.50	0.55	0.018	0.020	0.022
A1	0.00	0.02	0.05	0.000	0.001	0.002
b	0.45	0.50	0.55	0.018	0.020	0.022
c	0.12	0.15	0.18	0.005	0.006	0.007
D	0.95	1.00	1.05	0.037	0.039	0.041
e	0.65 BSC			0.026 BSC		
E	0.55	0.60	0.65	0.022	0.024	0.026
L	0.20	0.25	0.30	0.008	0.010	0.012
h	0.07	0.12	0.17	0.003	0.005	0.007

Suggested Land Pattern

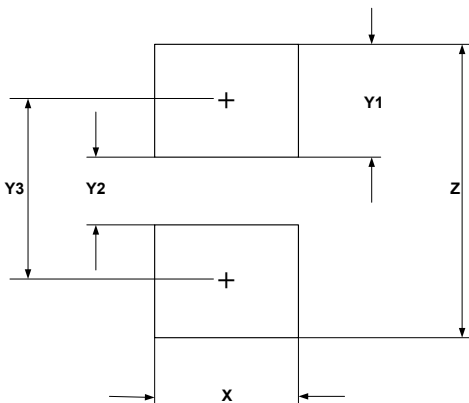

SYM	DIMENSIONS	
	MILLIMETERS	INCHES
X	0.60	0.024
Y1	0.50	0.020
Y2	0.30	0.012
Y3	0.80	0.032
Z	1.30	0.052

NOTICE

Jelan-Link reserves the right to make changes without further notice to any products here in.

Only obligations are those in the Jelam-Link Standard Terms and Conditions of Sale and in no case will Jelam-Link be liable for any incidental, indirect, or consequential damages arising from the sale, resale, use, or misuse of its products.